

Contents

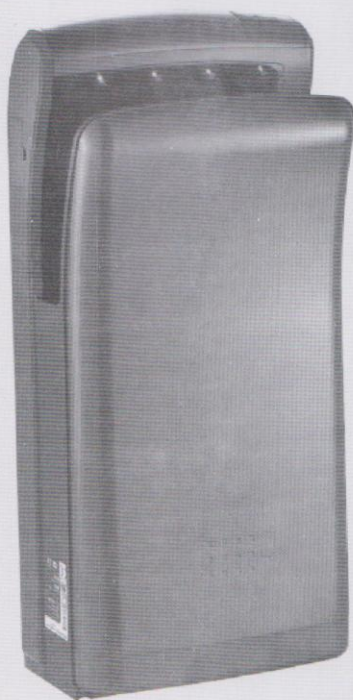

Page **1** Precautions

3 Components

4 How to Set up

5 How to Use

6 How to Manage

7 When Trouble Happens

8 Product Specification

Product Guarantee

Precautions

* The followings show what **Warning** and **Caution** mean.



Warning

Means that a serious injury or
decease may be caused,
unless use as described.



Caution

Means that a slight injury may
be caused or it may bedamaged,
unless use as described.



Prohibition



No Disassembly



No Touch



No Water



No Wet Hand



No Using in bathroom



Strict Advice



Pull out the supply cord from an outlet

Please read all instruction before using this product, It will help you to use it correctiy and safely.

Warning (Powering)

Insert the supply cord into a standardized outlet.
Use a standardized outiet,
and do not insert many plugs
at a time

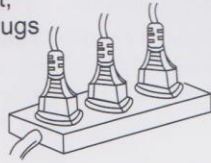

Be careful lest the supply cord is crushed
at the back of product.

Position it 10mm
at least away from
a wall.

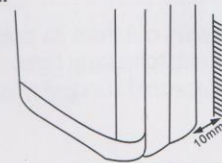

If the supply cord is damaged, it must be replaced
by a special cord or assembly available
from the manufacturer, its service.



Sweep the supply cord, and insert plug completely.

If the supply cord is incompletely inserted,
it may cause fire.
Dust is the same.

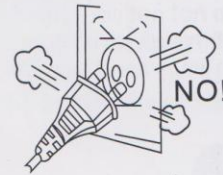

Warning (Handling)

Do not open a front cover.

An electric shock may be caused.



Do not disassemble it to try to repair it,
but a service engineer.

An injuly or an electric shock
may occur.



Do not put a heavy thing on it.

An injury may be caused by its fall.



Do not pour inflammables, such as ether,
benzene, a chemical agent,
alcohol, LP gas, etc., into it.

It can make any malfunction
to the product.



Mount it far away from the source of ignition including an electric heater, candle light, etc.

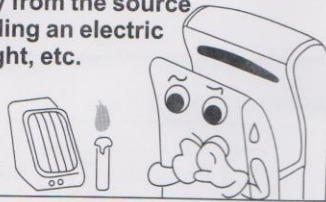

Do not put a container filled with water, a vase, a cup, a chemical agent, etc., on it.

Fire or an electric shock may be caused, and its fall may cause an injury or its trouble.



Do not water its inside or outside.



Do not hang on it.

Take special care lest children hang on it.



Caution

When pull a plug out, don't hold the end of the plug, but its code.
An electric shock may occur.



When a plug or its code is damaged or the hole of outlet is loose, do not use it.
An electric shock or fire may occur.

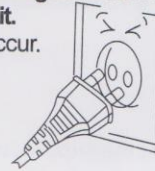

Pull a plug out from its outlet, when it is out of use for a long time.
An unexpected accident may be broken out.



Set up it on strong and straight wall.
The product set up on an instable wall may be fallen or vibrated.

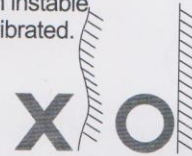

Do not put your hand inside it through its bottom.
An injury may be caused.

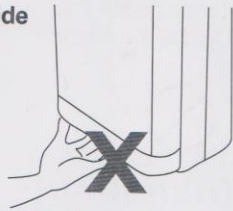

When carry it out, hold both sides.
An injury may be caused because your hands might slip.

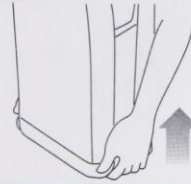

Do not insert or pull a plug out with wet hand.
An electric shock may be caused.



When sweep or handle it, turn off power switch. Then remove plug from outlet.
An electric shock or an injury may be caused

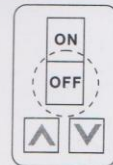

Do not pull out a drain tank and an air filter while it is being worked.
Water may leak out or an air purifier may be not worked.



If it does not work, turn off power switch. And review at page 7. If it does not work continuously, contact the customer service center please.

Components



		<p>(M4X38mm)</p>	<p>(M4X16mm)</p>
A link board	Vibration-absorbing packings	Link board-fixing screws Anchors	Sexangular fixing screws

How to set up

1 How to set up

This product must be worked with AC 220V~240V(50/60Hz).

Wiring must be followed the related standard.(A standardized wire must be used for interior wiring.)

Do not set up at the following place:(A trouble may be happened.)

Temperatures above 40℃ Bumpy surface Exposes to water
Exposed to direct rays or hard light Exposed to corrosive gas.

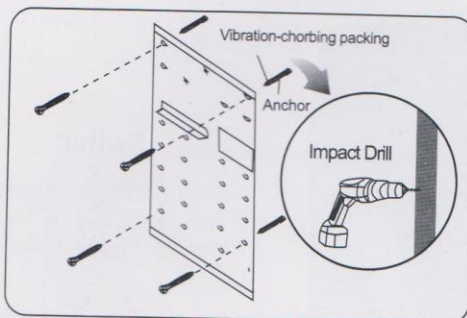

1. Fixing a link board(Consider environment)

When you determine the position of the holes, consider the balance of the weigh.

- (1) Drill four holes 30mm deep.
- (2) Insert the anchors into the holes.
- (3) Pass a plug through the hole that is at the back of product.
- (4) Fit the vibration-absorbing packings, and fix the link board with fixing screws.

*On a concrete wall, use metal-screwed plug
*On a weak walls, reinforce enough to set up the product.

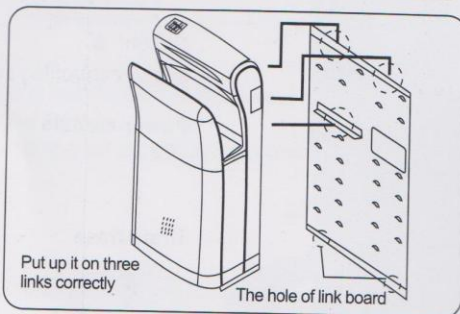

2. Putting up the product on the link board.

Put up the back cover of product on three links of the link board, and fix the product with screws pushing softly its body.

Fit it at the link.

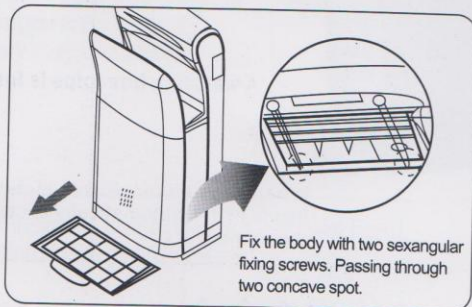

3. Fixing the product on the link board.

- (1) Separate a drain tank from the body.
- (2) Pull out an air filter from the body.
- (3) Fix the body with two sexangular fixing screws, passing them through two concave spot at the back of the air filter.



4. Checking work.

After inserting the plug into a standardized outlet, check whether it works, If it does not work, **turn off the power switch. And examine at page 7.** If it does not work continuously, **contact the customer service center please.**

Where to position.

- Position it 350mm at least from the floor.
- Position it 10mm at least from a wall.
- Position it on a straight and balanced wall
- Keep it away from a door or a place easy to bump to men.

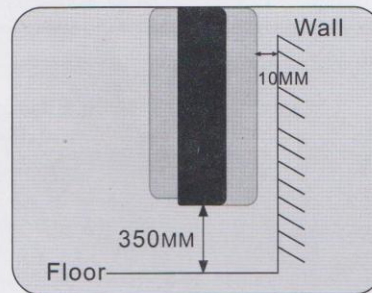

2 Test

- Do not turn on the power switch with your hand inside the dryer bin.
- After turning on the power switch, check whether it beeps and it correctly lights up its lamps.

3 Checkups

	Procedure	Checkup
1	Check power and its voltage.	Is it connected to the proper electric power?
2	Turn on a power switch.	① Does it light up the pilot lamps? ② Does it beep?
3	Put your hand into the drying part	Does wind come out?
4		Does it vibrate or make strange sounds?

How to set up

How to use

- Affix the right tag, which shows how to use, on a spot open to the view.

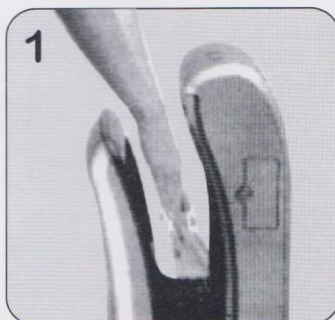

1 Place your outstretched hands into the dryer bin as shown.

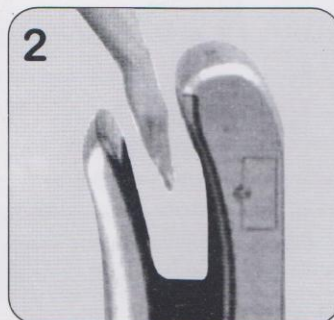

2 Pull your hands out slowly to eliminate water with jet wind gust.

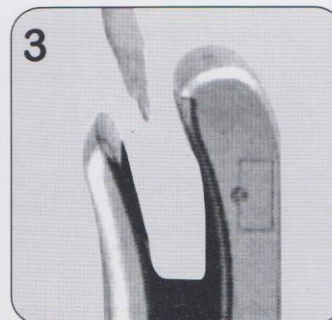

3 Repeat step 1 and 2, if necessary. Take your hands out of the unit.

How to Manage

1 Turn off the power switch to secure it.

2 When sweep its covers
 Use a soft towel with warm water or a detergent. After using a neutral detergent, be sure to wipe it using a wet towel.
 Do not use an abrasive, oils, benzene, thinner, hydrochloric acid, hot water, rough brush, etc., because they damage its cover or parts.
 Do not spray water directly to the product. An electric leak or a trouble may be happen.

3 When sweep drain tank or filter
 Be careful lest it is filled with water.
 Empty the water out of the tank, before sweeping it.
 Use a vacuum sweeper when sweep a filter, or replace with a new filter.

How to sweep the drain tank

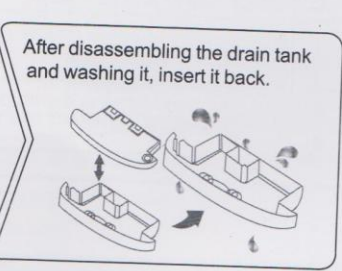
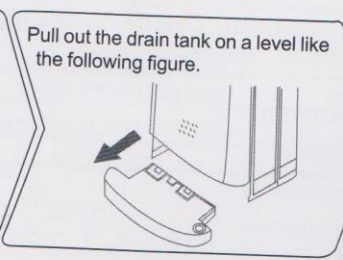
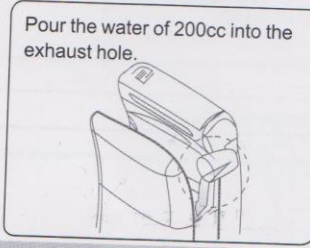

How to manage air filter

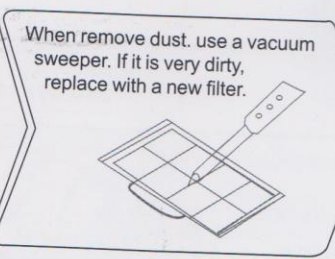
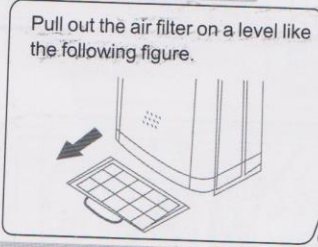

Caution!
 • After washing it dry it enough

How to replace an aromatic

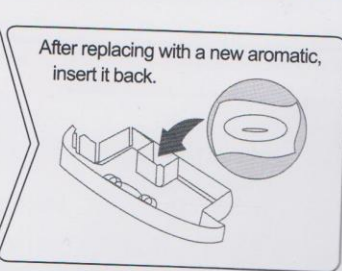
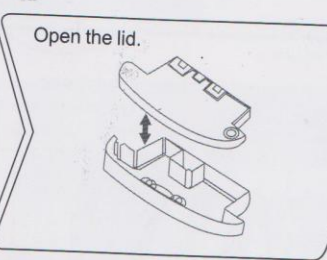
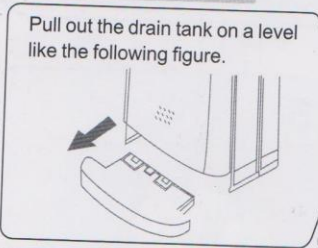

4 After sweeping them
 Turn on the power switch with a dry hand.

Changing the air filler and the aromatic

An air filter and an aroma(solid) must be periodically repiaced.
 For purchasing the expendabies contact the related agency or the customer seryioe center please.

appliances work.
Insert the plug into an outlet correctly.
Connect it to the voltage of AC 220~240V
Put your hand into the bin.

After shutting off power and sweeping
the sensor, turn on the switch.

Remove such things.

Sweep the filter.

Set up it on a strong and straight wall.

Remove such things.

Fix the bar firmly.

After emptying the water out of the tank,
sweep the tank.

Sweep it with warm water or vacuum
sweeper.

Fill it up with new aromatic.

Insert the water tank correctly.

Empty the water out of the tank.

After cutting power and sweeping
the sensor, turn on the switch.

Cleaning Tips

※ Daily cleaning is recommended

1

Switch off the 2nd button for safety.

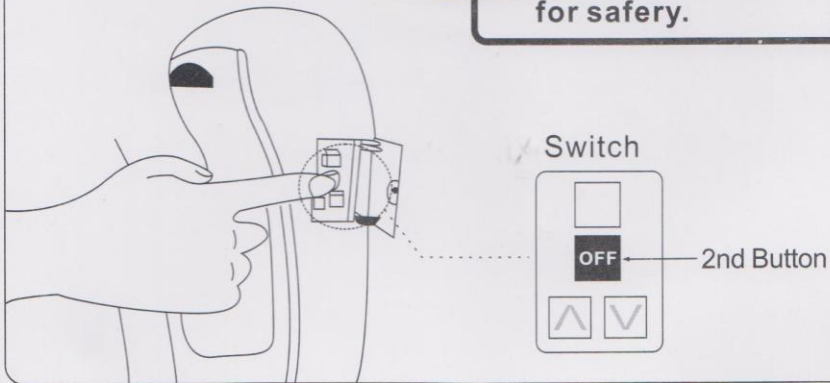

2

Pour a cup of water to the hole and brush up.

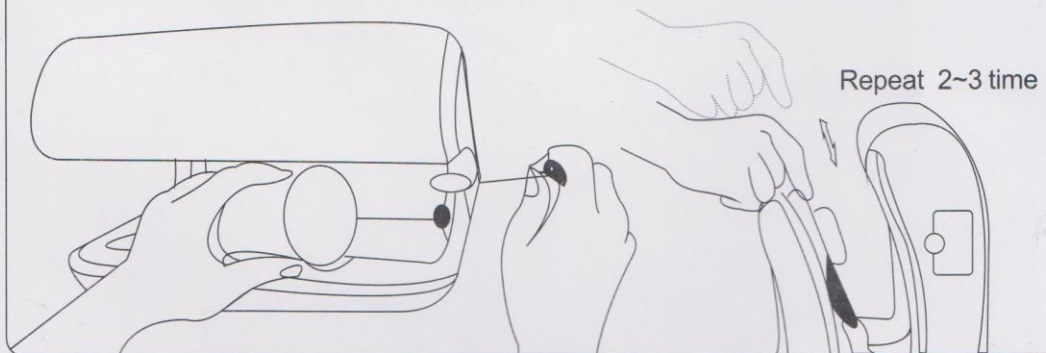

3

Make the drain tank empty and clean up

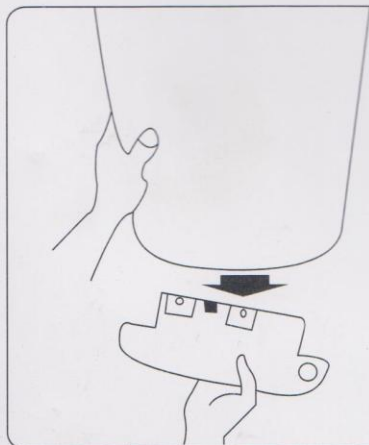

Switch on the 1st button for operation.

4

1st button

